



APPLICATIONS

- Touring sound reinforcement
- Theatres, Stadiums, Concert Halls, Arenas.....
- Ideal for both live applications assisted by one or both subs of the VHA range.

FEATURES

- Self powered 2-way line array
- Class D 600W for LF, 300W for HF amplifier
- DSP processor with 8 equalization presets
- Cabinet in 0,47" birch plywood with anti-scratch varnish
- Rubber-coated sides
- Possibility of vertical and horizontal installation through dedicated flybars
- Wide range of accessories for suspension, pole-mounting, ground-stacking
- Completely Manufactured in Italy



COLORS AVAILABLE BLACK



DESCRIPTION

The FBT HORIZON VHA 406A is a compact, self-powered line array element. The FBT HORIZON VHA 406A features 4 x 6,5" woofers plus a 1,4" neodymium compression driver with a 2,5" voice coil for a frequency response that extends from 65Hz to 20kHz. The Class D amplifier module is constructed in die-cast aluminum with natural convection to deliver 600W for the LF section and 300W for the HF, with switching power supply. The waveguide, designed specifically for this product and optimized with BEM (boundary element method), has a horizontal dispersion of 90° and vertical of 20°. The FBT HORIZON VHA 406A offers the possibility to choose between 8 pre-defined algorithms; the controls and connections panel features: Neutrik powercon connector for power supply with input and output, XLR in/link connectors, level control, HF level, preset selector, HP filter switch, two status led. The construction materials of The FBT HORIZON VHA 406A meet the highest professional standards to ensure maximum reliability; the cabinet is in birch plywood of 0,47" with anti-scratch varnish and is provided with two handles with rubber inserts and integrated mechanics to join the speakers and angle them from 5° to 20° in 5° steps. The FBT HORIZON VHA 406A also boats integrated quick-release anchor points that facilitate the creation of horizontal and vertical arrays using the dedicated flybar. The FBT HORIZON VHA 406A provides a wide range of accessories for suspension, pole-mounting or ground-stacking. The front of the loudspeaker is covered with a powder coated perforated steel grille. Available a rain cover that protects the electronic parts from the rain.

PERFORMANCE

System Type	2 ways bi-amplified line array
Built-in Amplifiers LF / HF *	max.: 600 / 300W RMS max. peak.: 1200 / 600W
Frequency Response @ -6dB	65Hz - 20kHz
Input Impedance	22kOhm
Maximum SPL (cont/peak) **	128/133dB
Dispersion	90°H x 20°V
Crossover Frequency	1,2 kHz
Power consumption	640 W
Nominal power requirement	220 - 230Vac 50/60Hz

* MAX: 2mS burst, RMS power on nominal speaker impedance
MAX PEAK: based on max peak output voltage and nominal speaker impedance

** CONT SPL: free space, based on power amp rating and LF transducer average sensitivity data, 125mS time average
PEAK SPL: free space, based on max power amp rating and system peak sensitivity, 10mS time average

PHYSICAL

Low Frequency Woofer	4 x 6,5" - 1,5" coil
High Frequency Driver	1 x 1,4" - 2,5" neodymium coil
Input Connectors	1 male + 1 female XLR IN/LINK
Net Dimensions (WxHxD)	24,1" x 14,2" x 15,6" 612 x 360 x 397mm
Shipping Dimensions (WxHxD)	28,34" x 16,14" x 20,27" 720 x 410 x 515
Net Weight	68,34 lbs / 31 kg
Shipping Weight	72,75 lbs / 33 kg
Enclosure Material	0,47" birch plywood
Power cord	16,40 ft / 5 mt.



HORIZON VHA 406A

Vertical Horizontal Active Line Array

FBT elettronica SpA

Via Paolo Soprani 1 - 62019 RECANATI - ITALY Tel. 071 750591 - Fax. 071 7505920 - email: info@fbt.it - www.fbt.it

CONNECTION PANEL

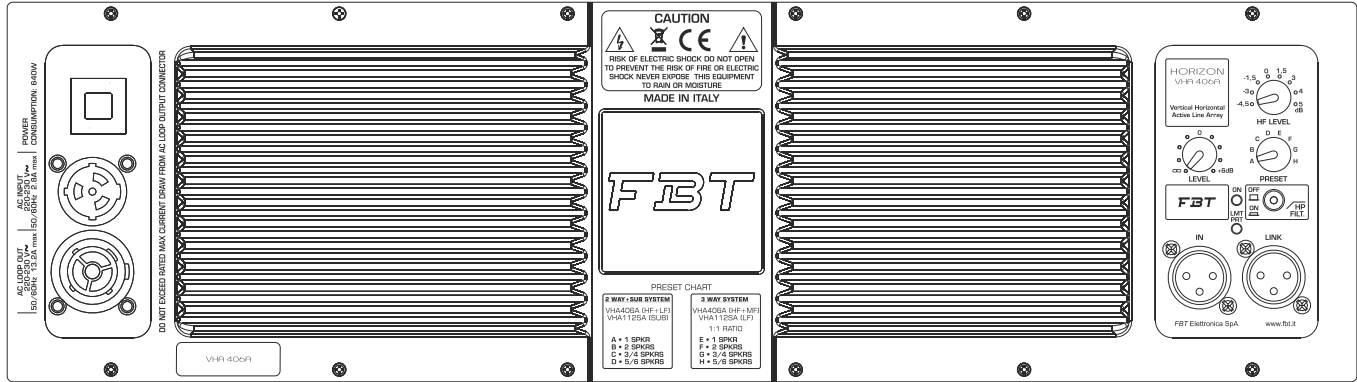

AMPLIFIER MODULE

The HORIZON VHA 406A provides a high-efficiency Class D power amplifier module with switching power supply enclosed in a die-cast aluminium chassis. This permits to protect the electronics against dust, avoid any air loss through the controls – which would cause annoying noises- and maximize heat loss by using the woofer ventilation instead of a cooling fan.

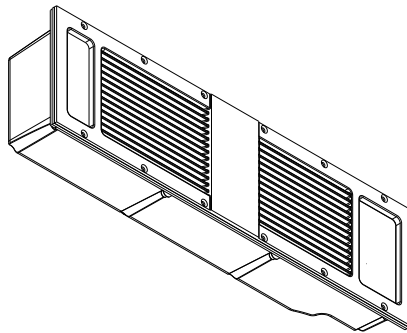

DIMENSIONAL DRAWING

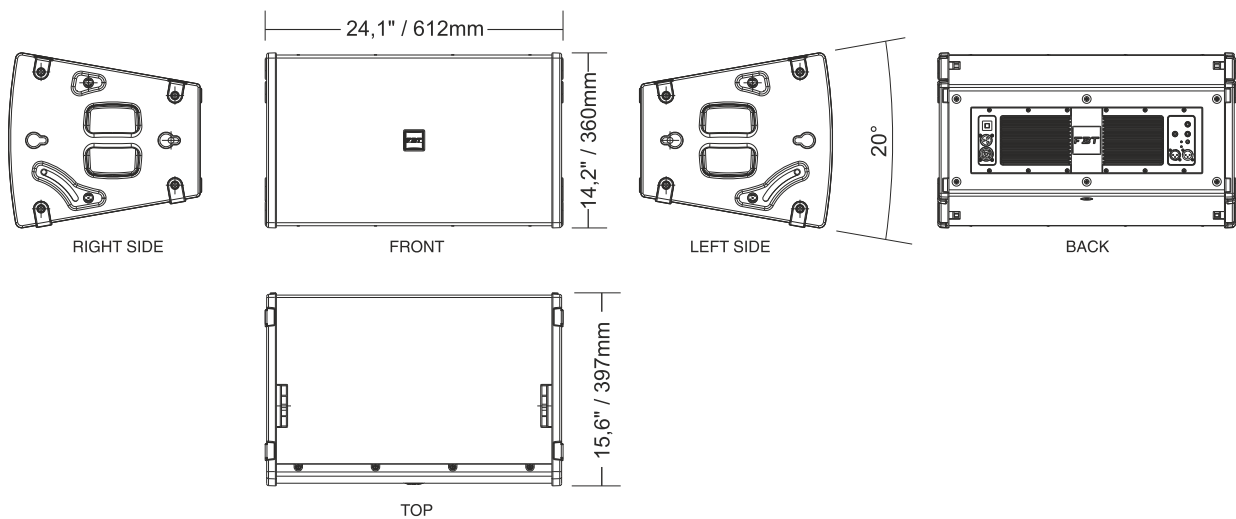



HORIZON VHA 406A

Vertical Horizontal Active Line Array

FBT elettronica SpA

Via Paolo Soprani 1 - 62019 RECANATI - ITALY Tel. 071 750591 - Fax. 071 7505920 - email: info@fbt.it - www.fbt.it

ACCESSORIES

VHA-FH 406-1

HORIZONTAL FLYBAR 1 SPEAKER

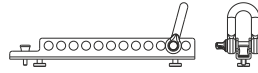

VHA-RC 406

RAIN COVER

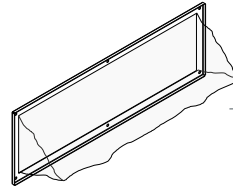

VHA-S 406

CLUSTER BRACKET WITH SPEAKER POLE

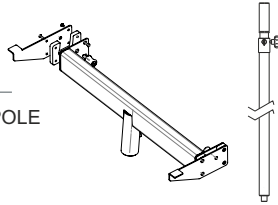

VHA-C 406/112

NYLON COVER

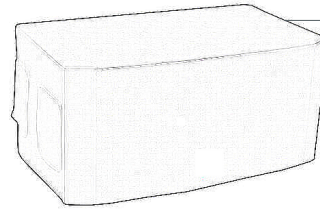

VHA-F 406

VERTICAL FLYBAR

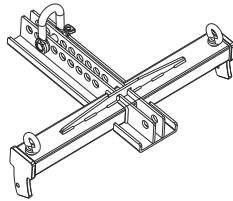

VHA-B 406

BASE TO GROUND ARRAY OR STACK ON SUB

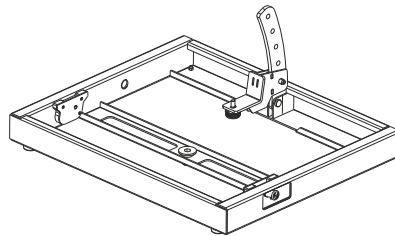

VHA-FH 406-5

HORIZONTAL FLYBAR 5 SPEAKERS

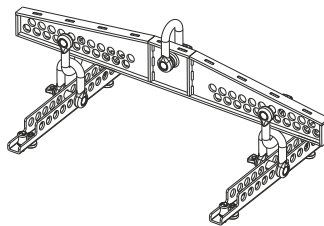

VHA-T 406

TROLLEY WITH STABILIZER FEET

